



**WORLD'S BEST  
ALLOY BULLBARS**

**East Coast Bullbars (ECB Pty Ltd)**

Tel: 07 3897 5700

Fax: 07 3283 1168

ecb@ecb.com.au www.ecb.com.au

29 Snook St  
Clontarf QLD 4019  
Australia

Po Box 122  
Margate QLD 4019  
Australia

**EAT217SY**

REPLACES: 00.00.00

REVISED: 04.08.17

## **FITTING INSTRUCTIONS**

### **TOYOTA HILUX 5/15on NARROW BODY (HALOGEN LIGHTS) ECB WINCH COMPATIBLE BIG TUBE™ BULLBAR VEHICLE FRONTAL PROTECTION SYSTEM (VFPS) FOR AIR BAG & ADR COMPLIANT VEHICLES**

Check installation hardware before commencing

1. Lift bonnet.
2. Remove eight plastic push pull clips from top panel between headlights and remove panel. **See figure 1.**
3. From top of grille, remove four 10mm head bolts. **See figure 2.**
4. Remove three 10mm head bolts from top of bumper behind grille.
5. From bumper behind grille, remove two plastic push pull clips. **See figure 3.**
6. Remove nine 10mm head bolts from underside of bumper, remove two plastic push pull clips from wheel arch per side, pull outwards on bumper wing to unclip from guard. Disconnect fog lights if required and slide bumper forward from vehicle.
7. Remove plastic bumper stiffener, three 10 mm head bolts and left and right hand air ducts and 3 push pull plastic clips (per side). **See figure 4.**
8. Remove plastic cushioning from front of bumper reinforcement by pulling it forward from vehicle to release christmas tree clips.
9. Remove two 14mm head bolts from bumper reinforcement (per side) and remove reinforcement.
10. Remove lower plastic from under radiator, two 10mm head bolts and 5 push pull clips.
11. Fit ECB winch cradle onto end of chassis rail and fix with two original bolts and two M10 x 40 mm bolts, flat washers, spring washers and nuts into front of rail (per side).( finger tighten only). From outside of chassis rail, install two M10 x 100mm bolts, flat washers into tow hook and steel mount through chassis rail, slide spacer tubes onto bolts then fit winch cradle gusset onto bolts and fix with flat washers, spring washers and nuts. **See figure 5.** In rear hole of ECB steel tow hook, install 6mm alloy washer between tow hook and chassis rail, fix using one M12 x 40mm bolts, spring washer and flat washer (supplied)(per side). Centralize cradle to vehicle body. Align and tighten all bolts.
12. Install fairlead roller to front of ECB winch frame using bolts supplied with winch. **Finger tighten only.**
13. Install control box mount (supplied) to rear of control box using bolts / nuts supplied with winch.
14. Install winch into ECB winch frame using bolts supplied with winch. Attach control box to winch using two worm drive hose clamps (supplied) for Warn control box mount and Mean Mother control box mount as per instructions supplied with winch.



**WORLD'S BEST  
ALLOY BULLBARS**

**East Coast Bullbars (ECB Pty Ltd)**

Tel: 07 3897 5700

Fax: 07 3283 1168

ecb@ecb.com.au www.ecb.com.au

29 Snook St  
Clontarf QLD 4019  
Australia

Po Box 122  
Margate QLD 4019  
Australia

15. Mark and trim air dams to fit around steel mounts. **See figure 6.**
16. Refit bumper stiffener to vehicle.
17. Check ECB template for correct sizing. Cut ECB template from this instruction using a sharp pair of scissors. Place template on vehicle to establish cut area. Mask cut area to avoid damage to surface of bumper. Using ECB bumper template mark out cut line, check cut line for correct and cut bumper with jigsaw or similar tool.
18. Remove bumper side locator and trim as per **figure 7.** (Each side)
19. Refit bumper locator to vehicle, fix with M6 x20mm bolt, flat washer and nyloc nut in top front hole. **See figure 8.** (Each side)
20. Refit bumper to vehicle and trim cut line with 3mm clip lock supplied.
21. Fit ECB LED indicator / park lights into protection bar as per instructions supplied with the LED indicator kit. (Insure light is correct way up). **See figure 9.**
22. Disconnect indicator and parking lights on vehicle. Install ECB quick click wiring harnesses (supplied) between disconnected harness and indicator / park lights on vehicle. Run wiring out from under lights ensuring clearance from sharp edges and moving parts.
23. Attach 6mm clip lock trim (supplied) to top of ECB protection bar. **See figures 10, 11 and 12.**
24. Install ECB protection bar onto steel mount using three M12 x 40mm bolts, flat washers, spring washers and nuts (per side). Align protection bar to front of vehicle and tighten all bolts. **See figures 13 and 14.**
25. **For vehicles with underbelly guards:** Using ECB back stop supplied (TO AVOID DAMAGE TO RADIATORS) drill outer holes in stone tray to 8mm. **See figure 15.**
26. **For 2WD and vehicles without underbelly guards:** Install lower underbelly guard mount plate to front cross member using two M10 x 30 bolts, spring washers and flat washers. Finger tighten only. **See figure 16.**
27. Install ECB centre under body guard using three M5 x 20mm Philips head bolts, flat washers and nyloc nuts in front holes, M6 x 25 mm bolts, flat washers and nyloc nuts in rear holes.
28. Install ECB side under body guards using two M5 x 20mm Philips head bolts, flat washers and nyloc nuts in front holes, M6 x 25mm bolts, flat washers and nyloc nuts in rear hole. (Each side)
29. Mark and trim liner to fit under body guard. **See figure 17.**
30. Trim sides of liner to tuck in behind channel end. Fix liner to under body guard with 8mm self drilling screws. (Pilot hole is recommended)

#### **ENSURE NUMBER PLATE IS CLEARLY VISABLE**

**Note:** When fitting / refitting the licence plate to the vehicle, ensure there is no obstruction to licence plate vision in accordance with local authorities. If required relocate licence plate to an alternate location.



East Coast Bullbars (ECB Pty Ltd)

Tel: 07 3897 5700

Fax: 07 3283 1168

ecb@ecb.com.au www.ecb.com.au

WORLD'S BEST  
ALLOY BULLBARS

29 Snook St  
Clontarf QLD 4019  
Australia

Po Box 122  
Margate QLD 4019  
Australia

**Further VFPS Notes:**

- a) Do not attach VFPS to the vehicle using anchorages not intended for this purpose (e.g. engine mounting bolts).
- b) Do not use this product for any vehicle make or model, other than those specified by the VFPS manufacturer.
- c) Do not remove the plaque or label from the VFPS.
- d) Do not modify the structure of the VFPS in any way.
- e) No accessory or fitment should project forward of the VFPS forward profile.
- f) **ENSURE THESE INSTRUCTIONS ARE LEFT WITH VEHICLE OWNER AND/OR OPERATOR.**

**IMPORTANT INFORMATION**

Periodically check bolts and nuts for correct tightness, especially if travelling on rough roads

**FITTING KIT**

1 – ECB winch frame	2 – M10 x 1.25 x 30 bolts
2 – Winch cradle gussets	18 – M10 flat washers
2 – Tow hooks	10 – M10 spring washers
1 – Warn winch control bracket	8 – M10 nuts
1 – Mean mother control bracket	2 – M6 x 20mm bolts
1 – Underbelly guard mount (EAT210SY_UC3MS)	5 – M6 x 25mm bolts
1 – Centre under body guard	28 – M6 flat washers
1 - Pair side under body guards	7 – M6 nyloc nuts
4 – 10 NB steel tube 53mm long	7 – M5 x 20mm bolts
2 – Alloy 40mm x 6mm washers	8 – M5 nyloc nuts
2 – Worm drive hose clamps	4 – 8-10 gauge self tapping screws
1 – ECB back stop plates	1 – ECB LED Indicator/Park light/DRL kit (ICLED105)
12 – M12 x 1.25 x 40mm bolts	1 – ECB Quick Click harness (IC15TOHLOIPDH)
22 – M12 flat washers	2 – Fog light surrounds
12 – M12 spring washers	2 – 6 mm clips lock 900 mm long
12 – M12 nuts	1 – 6 mm clips lock 650mm long
4 – M10 x 1.5 x 100mm bolts	2 – 3 mm clips lock 1200mm long
4 – M10 x 1.5 x 40 bolts	3 – 6mm air vent

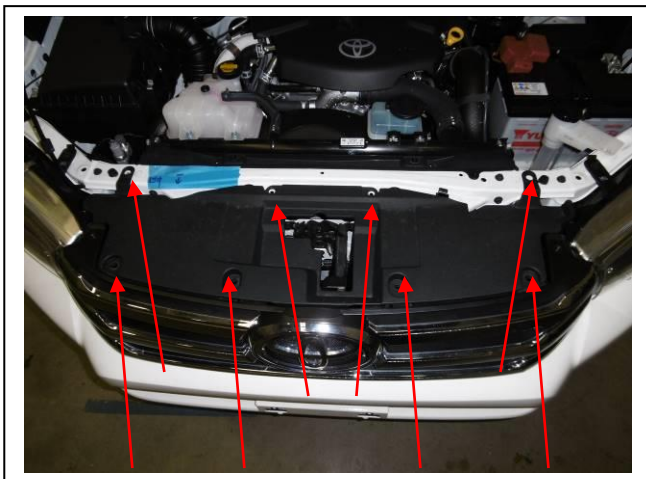

**Figure 1**

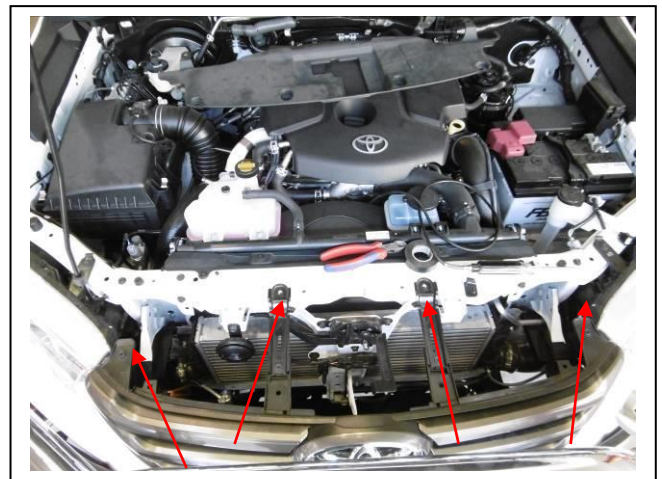

**Figure 2**



East Coast Bullbars (ECB Pty Ltd)

Tel: 07 3897 5700

Fax: 07 3283 1168

ecb@ecb.com.au www.ecb.com.au

WORLD'S BEST  
ALLOY BULLBARS

29 Snook St  
Clontarf QLD 4019  
Australia

Po Box 122  
Margate QLD 4019  
Australia

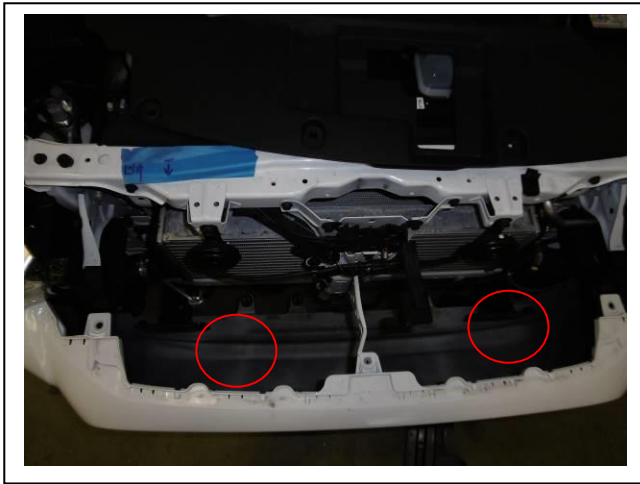

Figure 3. Remove two push pull clips

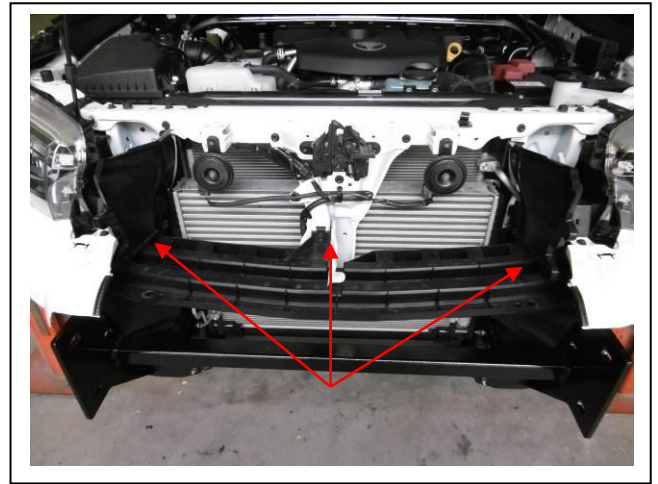

Figure 4. Remove three 10 mm bolts



Figure 5. Configuration of components

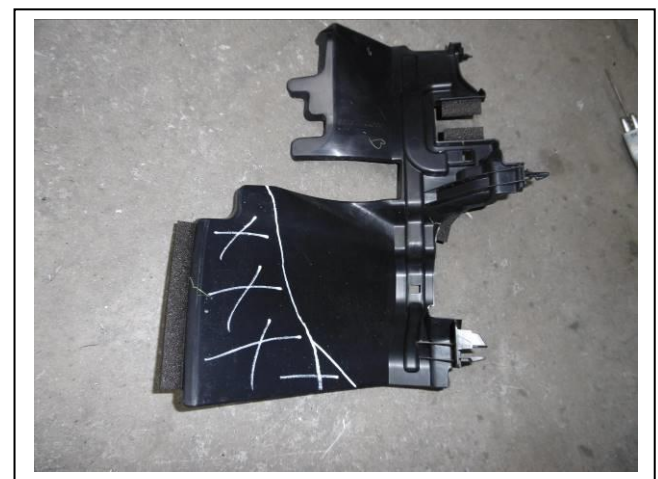

Figure 6. Trim air dam to fit around winch cradle

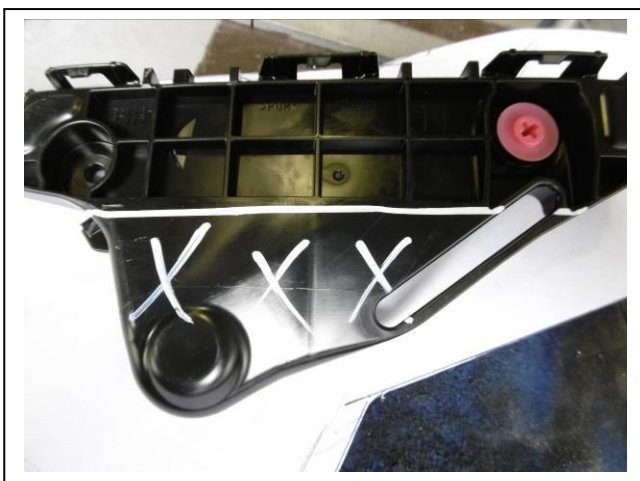

Figure 7. Locater trim line

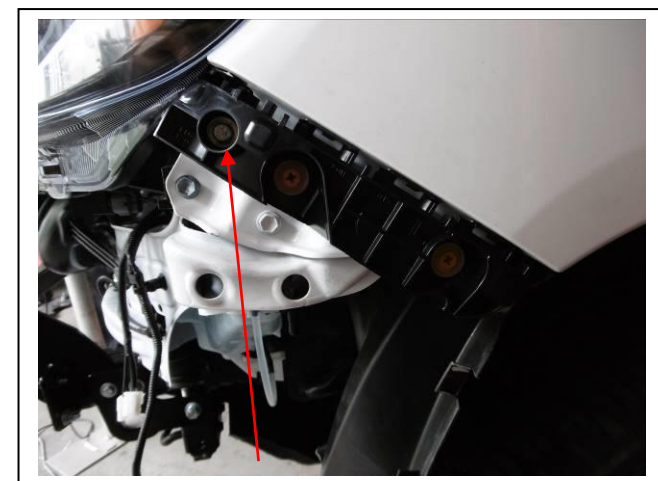

Figure 8. M6 bolt in locater fitted





East Coast Bullbars (ECB Pty Ltd)

Tel: 07 3897 5700

Fax: 07 3283 1168

ecb@ecb.com.au www.ecb.com.au

29 Snook St  
Clontarf QLD 4019  
Australia

Po Box 122  
Margate QLD 4019  
Australia

WORLD'S BEST  
ALLOY BULLBARS



Figure 9.

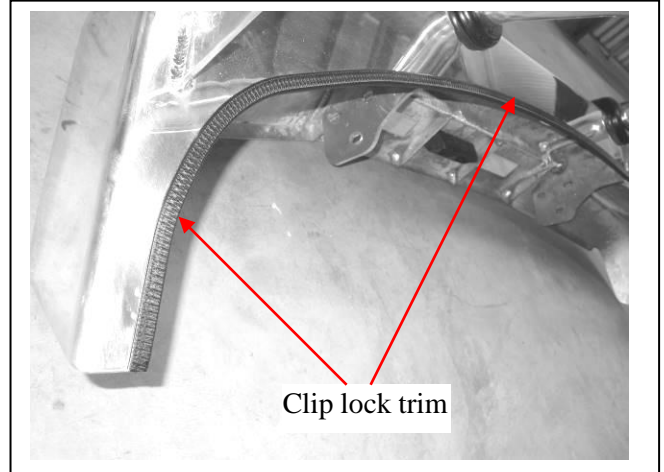

Figure 10.

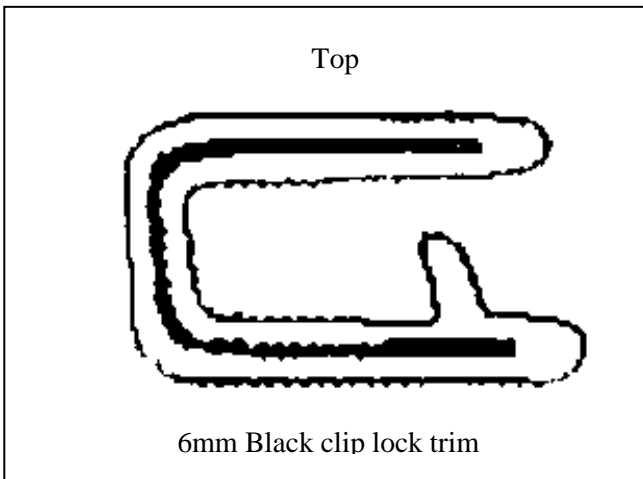

Figure 11.

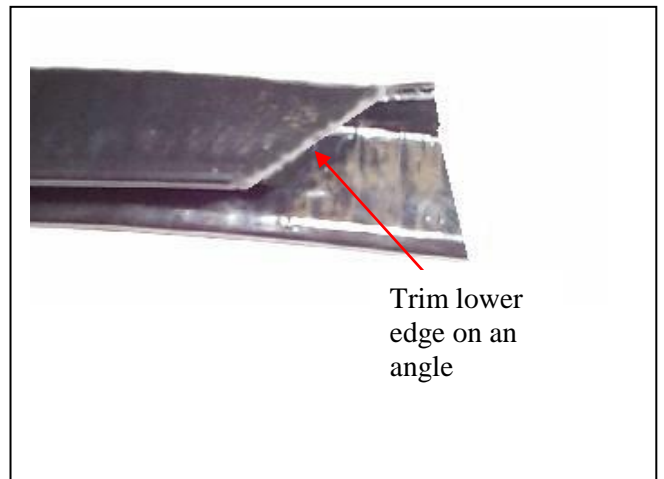

Figure 12.



Figure 13.



Figure 14.



**WORLD'S BEST  
ALLOY BULLBARS**

**East Coast Bullbars (ECB Pty Ltd)**

Tel: 07 3897 5700

Fax: 07 3283 1168

ecb@ecb.com.au www.ecb.com.au

29 Snook St  
Clontarf QLD 4019  
Australia

Po Box 122  
Margate QLD 4019  
Australia

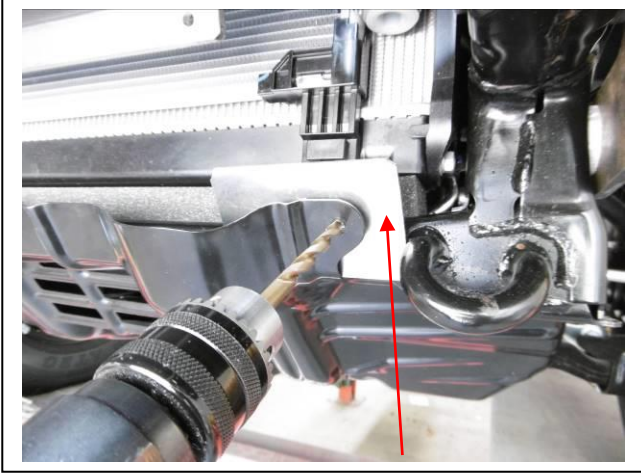

**Figure 15.** Back stop to protect radiators while drilling

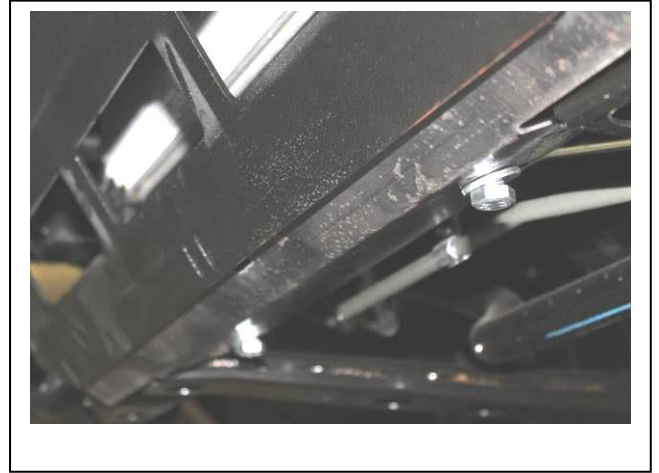

**Figure 16.**



**Figure 17.** Liner trimmed to fit



**Template Placement**



# NARROW BODY TEMPLATE PART A

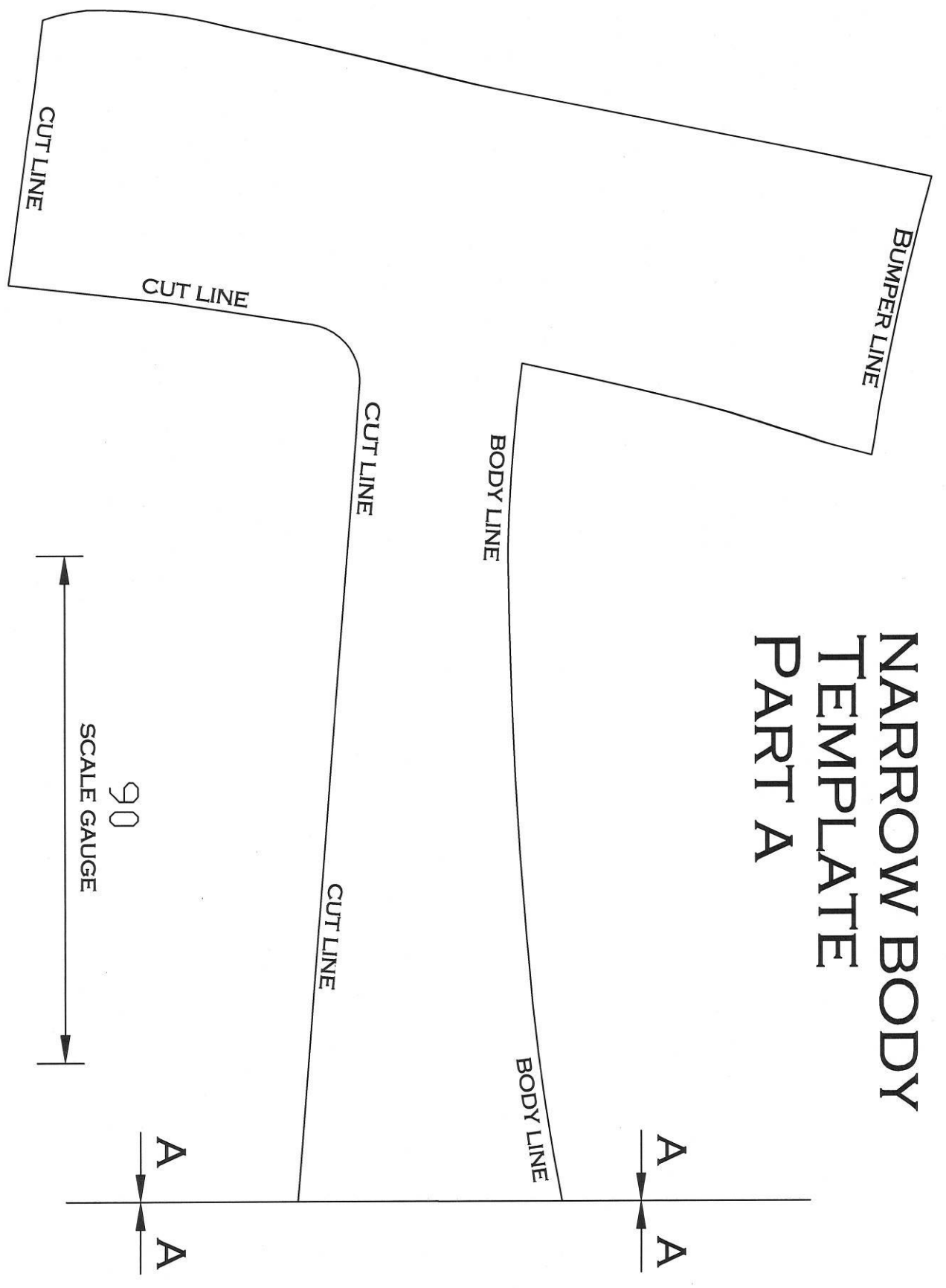



**WORLD'S BEST  
ALLOY BULLBARS**

**East Coast Bullbars (ECB Pty Ltd)**

Tel: 07 3897 5700

Fax: 07 3283 1168

ecb@ecb.com.au [www.ecb.com.au](http://www.ecb.com.au)

29 Snook St  
Clontarf QLD 4019  
Australia

Po Box 122  
Margate QLD 4019  
Australia



# NARROW BODY TEMPLATE PART B

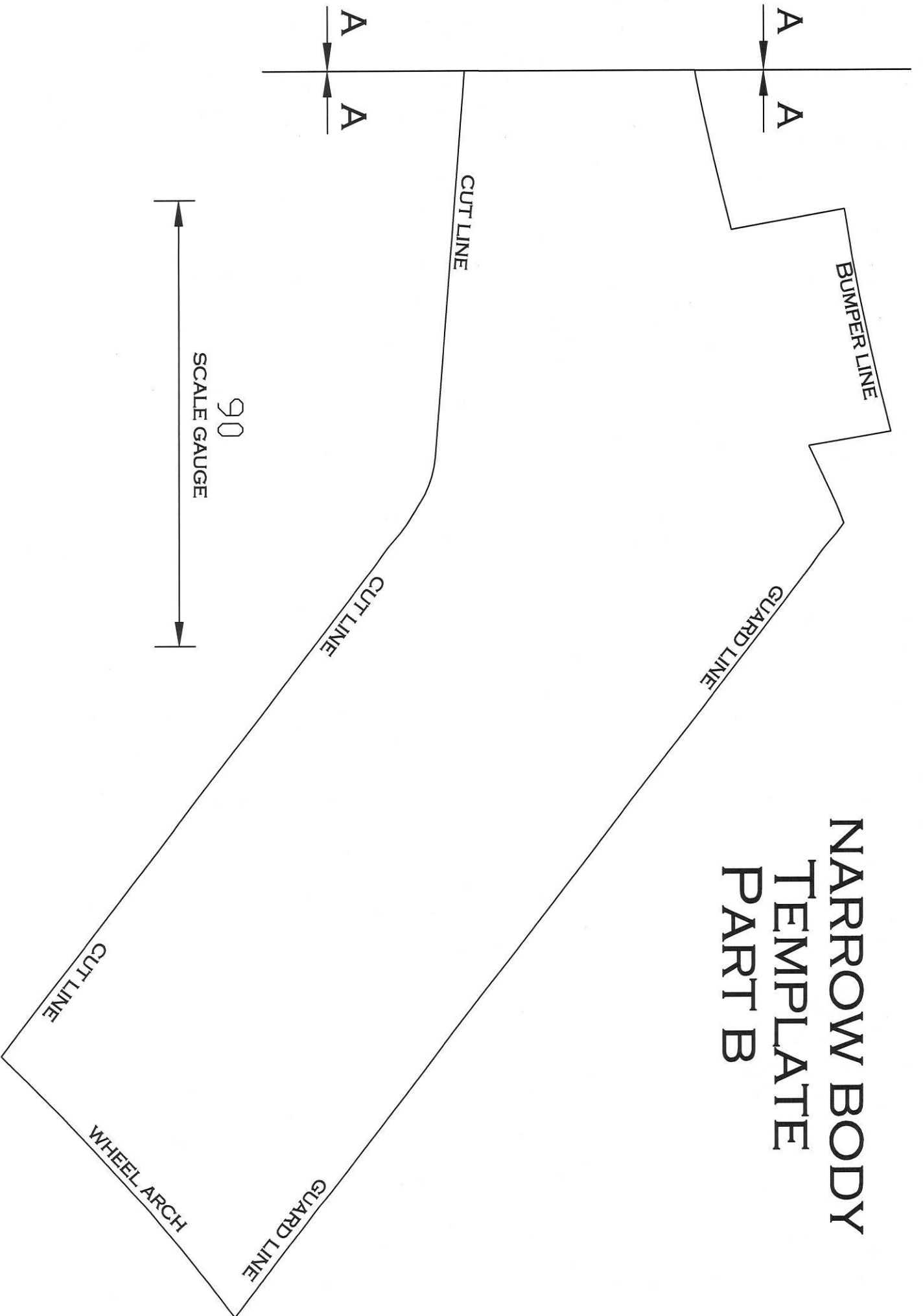



**WORLD'S BEST  
ALLOY BULLBARS**

**East Coast Bullbars (ECB Pty Ltd)**

Tel: 07 3897 5700

Fax: 07 3283 1168

[ecb@ecb.com.au](mailto:ecb@ecb.com.au) [www.ecb.com.au](http://www.ecb.com.au)

29 Snook St  
Clontarf QLD 4019  
Australia

Po Box 122  
Margate QLD 4019  
Australia

# GRILLE END TEMPLATE

90mm  
SCALE GAUGE





**WORLD'S BEST  
ALLOY BULLBARS**

**East Coast Bullbars (ECB Pty Ltd)**

Tel: 07 3897 5700

Fax: 07 3283 1168

ecb@ecb.com.au [www.ecb.com.au](http://www.ecb.com.au)

29 Snook St  
Clontarf QLD 4019  
Australia

Po Box 122  
Margate QLD 4019  
Australia





**WORLD'S BEST  
ALLOY BULLBARS**

**East Coast Bullbars (ECB Pty Ltd)**

Tel: 07 3897 5700

Fax: 07 3283 1168

ecb@ecb.com.au www.ecb.com.au

29 Snook St  
Clontarf QLD 4019  
Australia

Po Box 122  
Margate QLD 4019  
Australia

## *We value your comments*

Dear Fitter,

ECB would like to know how you went with the installation of this product. We value your comment and may need to contact you to clarify some details so please complete your contact details clearly.

We would appreciate if you could complete as many of the following details as possible.

<b>Your Name:</b>	<b>Your contact No.</b>
<b>Product Part No.</b>	<b>Product Invoice No.</b>
<b>Product Description:</b>	<b>Make, model, and year of vehicle:</b>
<b>Product Work Order No.</b>	<b>Company your from/Company product purchased from:</b>

**Date of Fitment:** \_\_\_\_/\_\_\_\_/\_\_\_\_

Was the fitting hardware supplied complete?

Yes

No

If no what was not supplied

---

---

Did the installation go well?

Yes

No

Please provide comments

---

---

---

Please draw diagrams if you need to.

**Post to**  
Reply Paid 122  
PO Box 122  
Margate QLD 4019

**Fax to**  
(07) 3283 1168



**WORLD'S BEST  
ALLOY BULLBARS**

**East Coast Bullbars (ECB Pty Ltd)**

Tel: 07 3897 5700

Fax: 07 3283 1168

[ecb@ecb.com.au](mailto:ecb@ecb.com.au) [www.ecb.com.au](http://www.ecb.com.au)

29 Snook St  
Clontarf QLD 4019  
Australia

Po Box 122  
Margate QLD 4019  
Australia



WORLD'S BEST  
ALLOY BULLBARS

East Coast Bullbars (ECB Pty Ltd)

Tel: 07 3897 5700

Fax: 07 3283 1168

ecb@ecb.com.au www.ecb.com.au

29 Snook St  
Clontarf QLD 4019  
Australia

Po Box 122  
Margate QLD 4019  
Australia

## DESPATCH CHECKLIST EAT217SY

Work Order #		<b>See other side of this page for photos of all mounts</b>
Finish:		
Transport:		
Due Date:		

OC.....1 – Winch cradle.

OC.....2 – tow hooks

OC.....1 – Pair steel brackets

OC.....1 - Pair side under body guards

OC.....1 – Centre under body guard (small)

OC.....1 – Underbelly guard mount (EAT210SY\_UC3MS)

BK.....1 – Bolt Kit.

BK.....1 – Indi/Park /DRL kit – ICLED105

BK.....1 – Quick click harness (IC15TOHLOIPDH)

OC.....1 – Pair ECB overrides (fitted to bar)

OC.....2 – 6mm air scoops (fitted to bar, skirt only ECB to bottom)

BK.....2 – Fog light surrounds

BK.....2 – 3 mm clips lock 1200mm long

BK.....1 – 6 mm clips lock 650mm long

BK.....2 – 6 mm clips lock 900 mm long

\_\_\_\_\_/\_\_\_\_\_  
Wrapper's initials / Checker initials

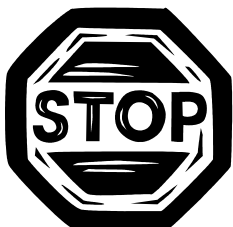

**Is this product “the best it can be” Yes**  
If **NO** fix before continuing

All parts checked and completed by:

Nut and bolts: \_\_\_\_\_ Date \_\_/\_\_/\_\_

Order control: \_\_\_\_\_ Date \_\_/\_\_/\_\_

Final wrap check: \_\_\_\_\_ Date \_\_/\_\_/\_\_



**WORLD'S BEST  
ALLOY BULLBARS**

**East Coast Bullbars (ECB Pty Ltd)**

Tel: 07 3897 5700

Fax: 07 3283 1168

ecb@ecb.com.au www.ecb.com.au

29 Snook St  
Clontarf QLD 4019  
Australia

Po Box 122  
Margate QLD 4019  
Australia

Requires "N" in front of side underbelly plates



\_\_\_\_\_  
Wrapper's initials / Checker initials

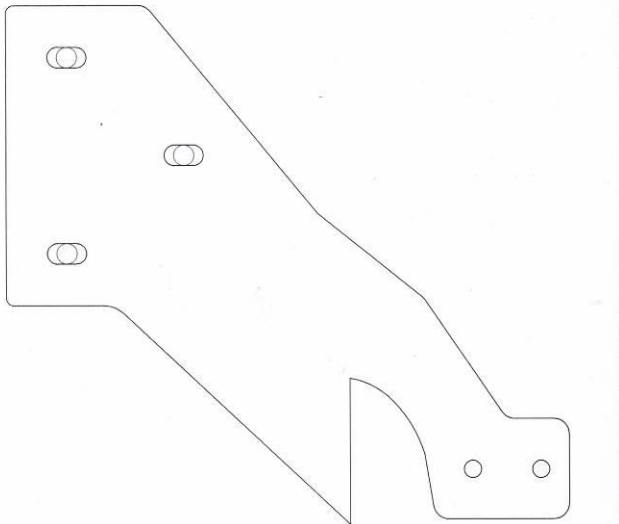

**PROFILE MUST BE  
STRAIGHT**

