



**WORLD'S BEST
ALLOY BULLBARS**

East Coast Bullbars (ECB Pty Ltd)

Tel: 07 3897 5700

Fax: 07 3283 1168

ecb@ecb.com.au www.ecb.com.au

29 Snook St
Clontarf QLD 4019
Australia

Po Box 122
Margate QLD 4019
Australia

EAT216SY

REPLACES: 00.00.00

REVISED: 04.08.17

FITTING INSTRUCTIONS

TOYOTA HILUX 5/15on NARROW BODY (HALOGEN LIGHTS) ECB BIG TUBE™ BULLBAR VEHICLE FRONTAL PROTECTION SYSTEM (VFPS) FOR AIR BAG & ADR COMPLIANT VEHICLES

Check installation hardware before commencing

1. Lift bonnet.
2. Remove eight plastic push pull clip from top panel between headlights and remove panel. **See figure 1.**
3. From top of grille, remove four 10mm head bolts. **See figure 2.**
4. Remove three 10mm head bolts from top of bumper behind grille.
5. From bumper behind grille, remove two plastic push pull clip. **See figure 3.**
6. Remove nine 10mm head bolts from underside of bumper, remove two plastic push pull clips from wheel arch per side, pull outwards on bumper wing to unclip from guard. Disconnect fog lights if required and slide bumper forward from vehicle.
7. Remove plastic bumper stiffener, three 10mm head bolts and left and right hand air ducts, 3 push pull plastic clips (per side). **See figure 4.**
8. Remove plastic cushioning from front of bumper reinforcement by pulling it forward from vehicle to release christmas tree clips.
9. Remove two 14mm head bolts from bumper reinforcement (per side) and remove reinforcement.
10. Remove lower plastic from under radiator, two 10mm head bolts and 5 push pull clips.
11. Fit ECB steel mount onto end of chassis rail and fix with two original bolts and two M10 x 40mm bolts, flat washers, spring washers and nuts into front of rail (per side). (finger tight). From inside of chassis rail, install two M10 x 100mm bolts, flat washers, washer plate and spacer tubes through chassis rail and ECB steel mount. On outside of these bolts, fit ECB Steel tow hook, flat washer, spring washers and nuts. In rear hole of ECB steel tow hook, install 6mm alloy washer between tow hook and chassis rail, fit using one M12 x 40mm bolt, spring washer and flat washer (supplied)(per side). Centralize mount to vehicle body. Align and tighten all bolts. **See figure 5.**
12. Mark and trim air dams to fit around steel mounts. **See figure 6.** Refit to vehicle.
13. Refit plastic bumper stiffener to vehicle.
14. Check ECB template for correct sizing. Cut ECB template from this instruction using a sharp pair of scissors. Place template on vehicle to establish cut area. Mask cut area to avoid damage to surface of bumper. Using ECB bumper template mark out cut line, check cut line for correct and cut bumper with jigsaw or similar tool.
15. Remove bumper side locator and trim as per **figure 7.** Two plastic screw clips (Per side).



**WORLD'S BEST
ALLOY BULLBARS**

East Coast Bullbars (ECB Pty Ltd)

Tel: 07 3897 5700

Fax: 07 3283 1168

ecb@ecb.com.au www.ecb.com.au

29 Snook St
Clontarf QLD 4019
Australia

Po Box 122
Margate QLD 4019
Australia

16. Refit bumper locator to vehicle, fix with M6 x20mm bolt, flat washer and nyloc nut in top front hole (per side). **See figure 8.**
17. Refit bumper to vehicle and trim cut line with 3mm clip lock supplied.
18. Fit ECB LED indicator / park lights into protection bar as per instructions supplied with the LED indicator kit. Ensure light is correct way up. **See figure 9.**
19. Disconnect indicator and parking lights on vehicle. Install ECB quick click wiring harnesses (supplied) between disconnected harness and indicator / park lights on vehicle. Run wiring out from under lights ensuring clearance from sharp edges and moving parts.
20. Attach 6mm clip lock trim (supplied) to top of ECB protection bar.
21. Install ECB protection bar onto steel mount using three M12 x 40mm bolts, flat washers, spring washers and nuts (per side). Align protection bar to front of vehicle and tighten all bolts. **See figures 10 and 11.**
22. **For vehicles with underbelly guards:** Using ECB back stop supplied (TO AVOID DAMAGE TO RADIATORS) drill outer holes in stone tray to 8mm. **See figure 12.**
23. **For 2WD and vehicles without underbelly guards:** Install lower underbelly guard mount plate to front cross member using two M10 x 30 bolts, spring washers and flat washers. Finger tighten only. **See figure 13.**
24. Install ECB centre under body guard using three M5 x 20mm Philips head bolts, flat washers and nyloc nuts in front holes, M6 x 25mm bolts, flat washers and nyloc nuts in rear holes.
25. Install ECB side under body guards using two M5 x 20mm Philips head bolts, flat washers and nyloc nuts in front holes, M6 x 25mm bolts, flat washers and nyloc nuts in rear hole. (per side)
26. Trim sides of liner to tuck in behind channel end.
27. Mark and trim liner to fit under body guard. **See figure 14.** Fix liner to under body guard with 8mm self drilling screws. (Pilot hole is recommended)

ENSURE NUMBER PLATE IS CLEARLY VISABLE

Note: When fitting/refitting the licence plate to the vehicle, ensure there is no obstruction to licence plate vision in accordance with local authorities. If required relocate licence plate to an alternate location.

Further VFPS Notes:

- a) Do not attach VFPS to the vehicle using anchorages not intended for this purpose (e.g. engine mounting bolts).
- b) Do not use this product for any vehicle make or model, other than those specified by the VFPS manufacturer.
- c) Do not remove the plaque or label from the VFPS.
- d) Do not modify the structure of the VFPS in any way.
- e) No accessory or fitment should project forward of the VFPS forward profile.
- f) **ENSURE THESE INSTRUCTIONS ARE LEFT WITH VEHICLE OWNER AND/OR OPERATOR.**

IMPORTANT INFORMATION

Periodically check bolts and nuts for correct tightness, especially if travelling on rough roads



East Coast Bullbars (ECB Pty Ltd)

Tel: 07 3897 5700

Fax: 07 3283 1168

ecb@ecb.com.au www.ecb.com.au

29 Snook St
Clontarf QLD 4019
Australia

Po Box 122
Margate QLD 4019
Australia

**WORLD'S BEST
ALLOY BULLBARS**

FITTING KIT

1 – ECB Steel mount	18 – M10 flat washers
2 – Washer plates	10 – M10 spring washers
2 – Tow hooks	8 – M10 nuts
1 – Underbody guard mount (EAT210SY_UC3MS)	2 – M6 x 20mm bolts
1 – Centre under body guard	5 – M6 x 25mm bolts
1 - Pair side under body guards	14 – M6 flat washers
4 – 10 NB steel tubes 53mm long	7 – M6 nyloc nuts
2 – 40 x 6mm round alloy washers	7 – M5 x 20mm phillips head bolts
1 – ECB back stop plate	14 – M5 flat washers
10 – M12 x 1.25 x 40 bolts	7 – M5 nyloc nuts
14 – M12 flat washers	4 – 8-10 gauge hex self tapping screws
10 – M12 spring washers	1 – ECB LED Indicator/Park light/DRL kit (ICLED105)
6 – M12 nuts	1 – ECB quick click harness kit (IC15TOHLOIPDH)
4 – M 10 x 1.5 x 100mm bolts	2 – 6 mm clips lock 800 mm long
4 – M10 x 1.5 x 40 bolts	2 – 3 mm clips lock 400 long
2 – M10 x 1.25 x 30	3 – 3mm air vent

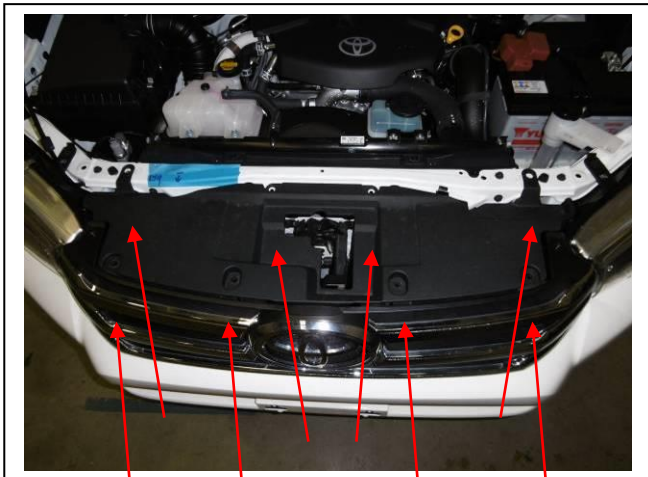

Figure 1

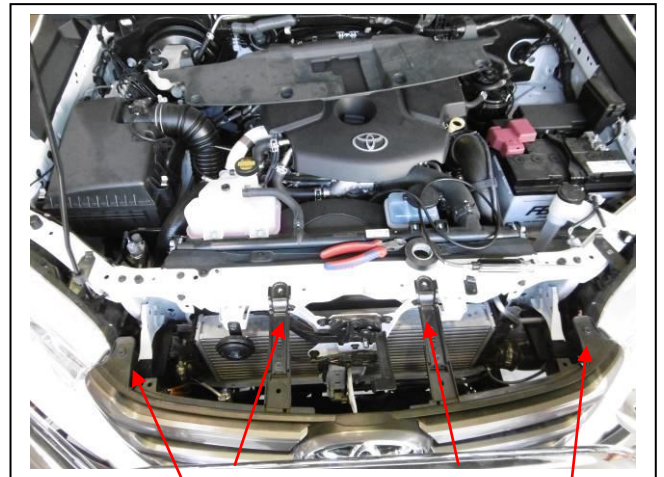

Figure 2

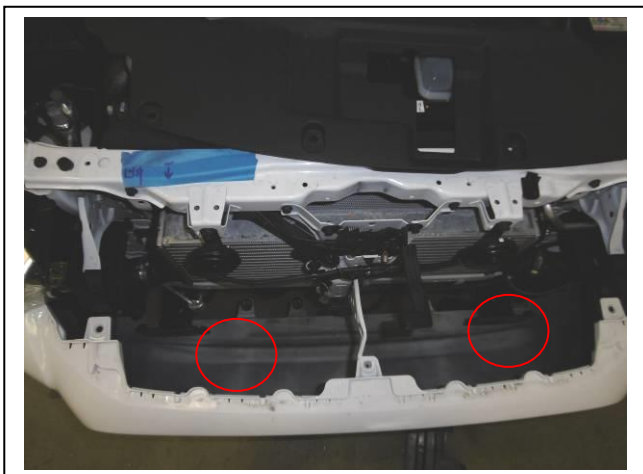

Figure 3

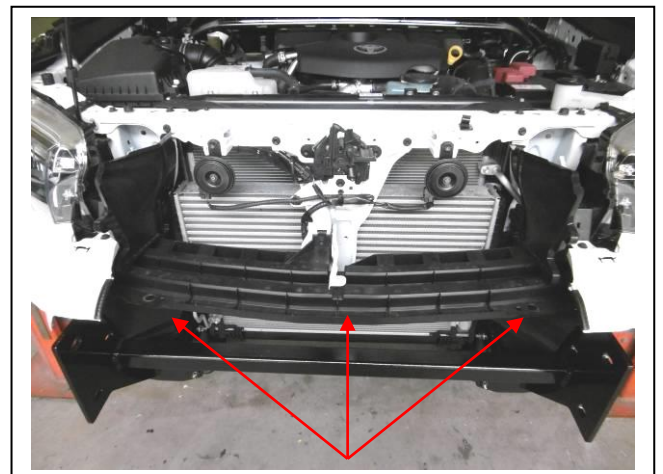

Figure 4.



East Coast Bullbars (ECB Pty Ltd)

Tel: 07 3897 5700

Fax: 07 3283 1168

ecb@ecb.com.au www.ecb.com.au

WORLD'S BEST
ALLOY BULLBARS

29 Snook St
Clontarf QLD 4019
Australia

Po Box 122
Margate QLD 4019
Australia



Figure 5. configuration of components

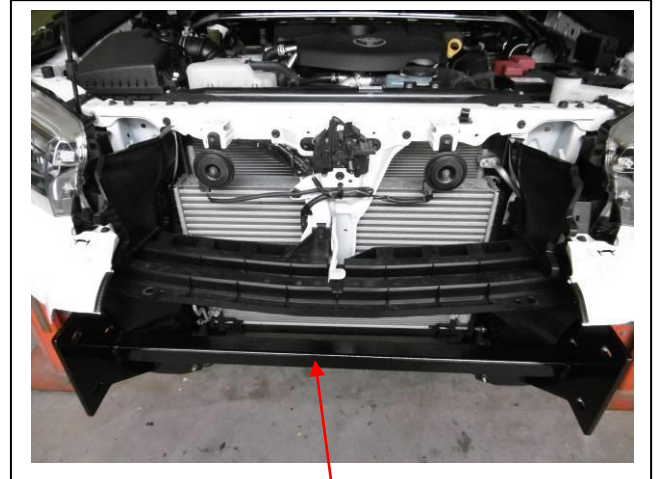

Figure 6. Steel mount fitted

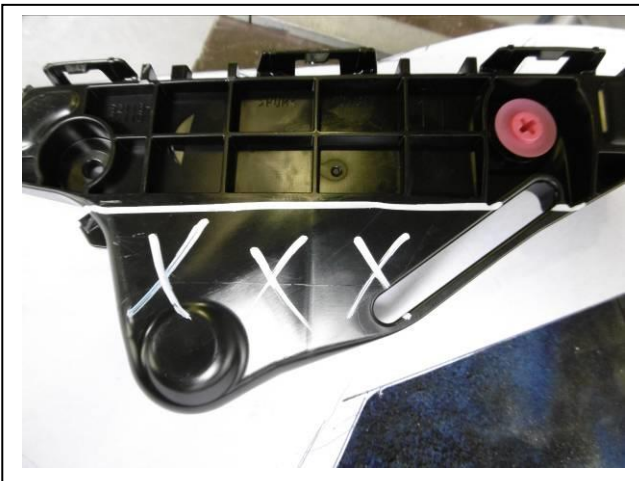

Figure 7. locater trim line

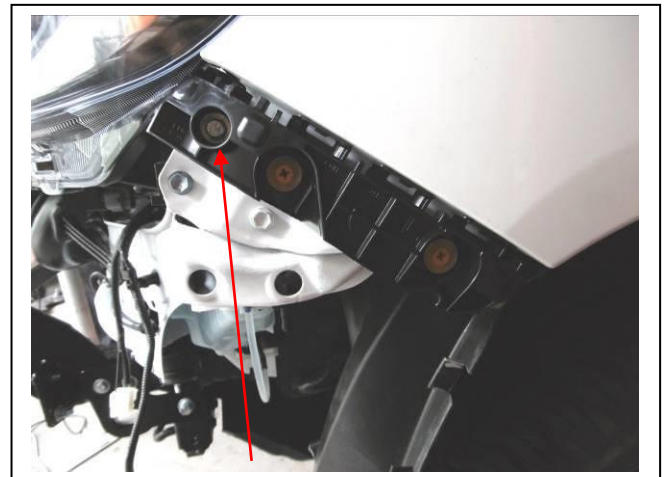

Figure 8. locater fitted

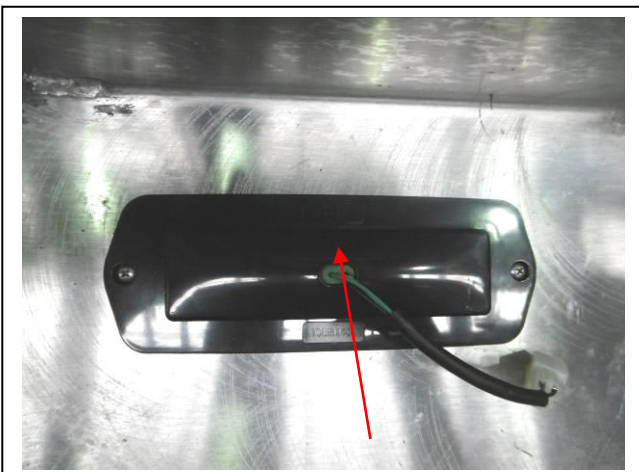

Figure 9. Top



Figure 10.



East Coast Bullbars (ECB Pty Ltd)

Tel: 07 3897 5700

Fax: 07 3283 1168

ecb@ecb.com.au www.ecb.com.au

29 Snook St
Clontarf QLD 4019
Australia

Po Box 122
Margate QLD 4019
Australia

WORLD'S BEST
ALLOY BULLBARS



Figure 11.

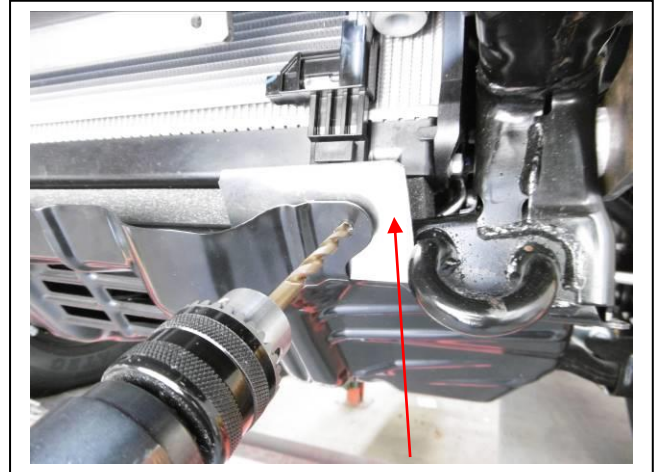

Figure 12. Back stop to protect radiators while drilling



Figure 13.



Figure 14. Liner trimmed to fit



Template Placement



Template Placement

NARROW BODY TEMPLATE PART A

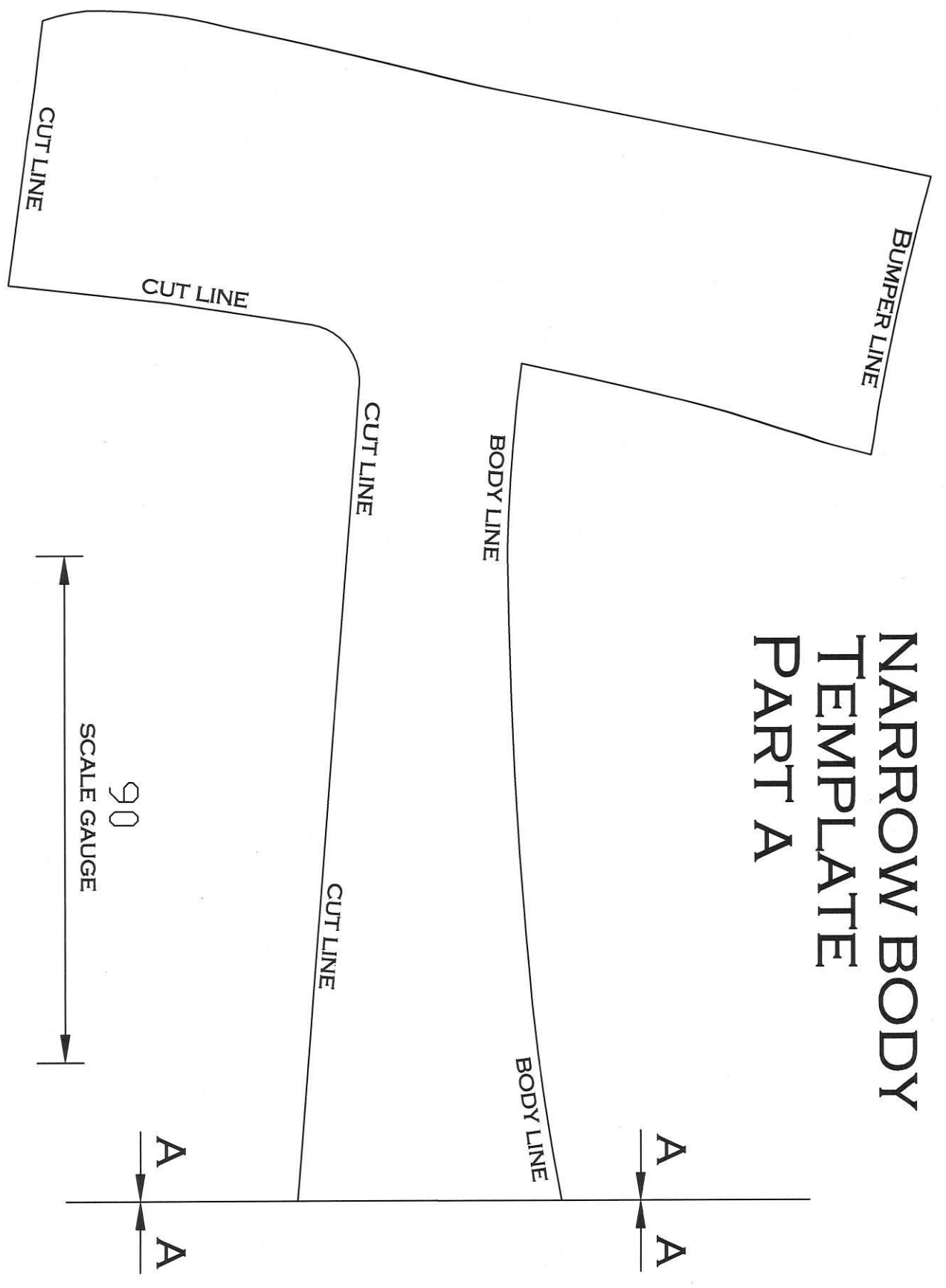

NARROW BODY TEMPLATE PART B

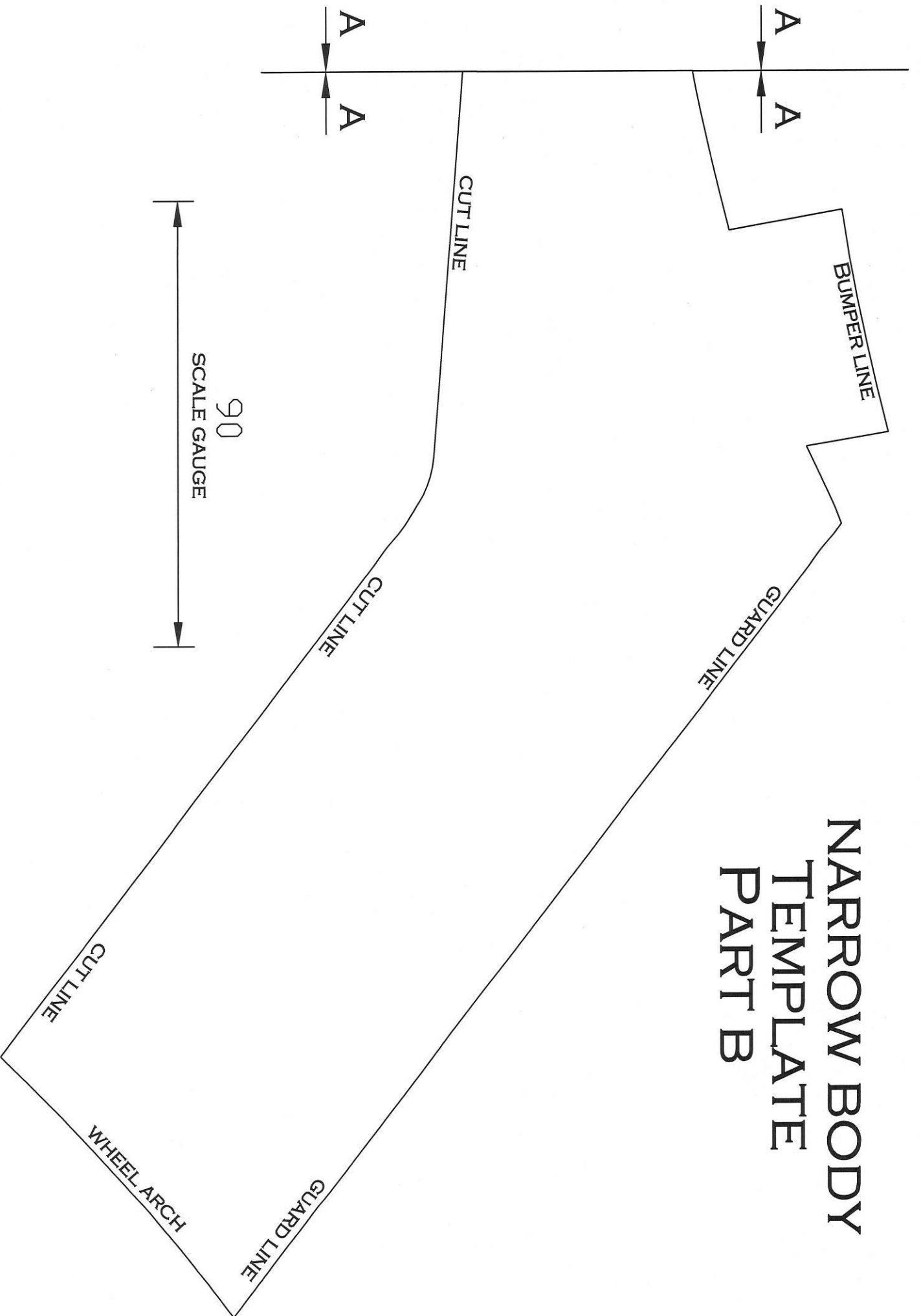

GRILLE END TEMPLATE

90mm
SCALE GAUGE



Template Placement



**WORLD'S BEST
ALLOY BULLBARS**

East Coast Bullbars (ECB Pty Ltd)

Tel: 07 3897 5700

Fax: 07 3283 1168

ecb@ecb.com.au www.ecb.com.au

29 Snook St
Clontarf QLD 4019
Australia

Po Box 122
Margate QLD 4019
Australia

EAT216SY

Work Order #		See other side of this page for photos of all mounts
Finish:		
Transport:		
Due Date:		

- OC.....1 - Steel mounting bracket.
- OC.....2 - ECB steel tow brackets
- OC.....1 - Pair side under body guards
- OC.....1 - Centre under body guard (large)
- OC.....1 – Underbelly guard mount (EAT210SY_UC3MS)
- BK.....1 - Bolt Kit.
- BK.....1 - Indicator / park kit / DRL Kit (ICLED105ECB)
- BK.....1 - Quick click harness (IC15TOHLOIPDH)
- OC.....1 - Pair ECB overrides (fitted to bar)
- OC.....7 - 6mm air scoops (fitted to bar, skirt only ECB to bottom)

_____/_____
Wrapper's initials / Checker initials



Is this product “the best it can be” Yes
If **NO** fix before continuing

All parts checked and completed by:

Nut and bolts: _____ Date __/__/__

Order control: _____ Date __/__/__

Final wrap check: _____ Date __/__/__



WORLD'S BEST
ALLOY BULLBARS

East Coast Bullbars (ECB Pty Ltd)

Tel: 07 3897 5700

Fax: 07 3283 1168

ecb@ecb.com.au www.ecb.com.au

29 Snook St
Clontarf QLD 4019
Australia

Po Box 122
Margate QLD 4019
Australia

Requires "N" in front of side underbelly plates

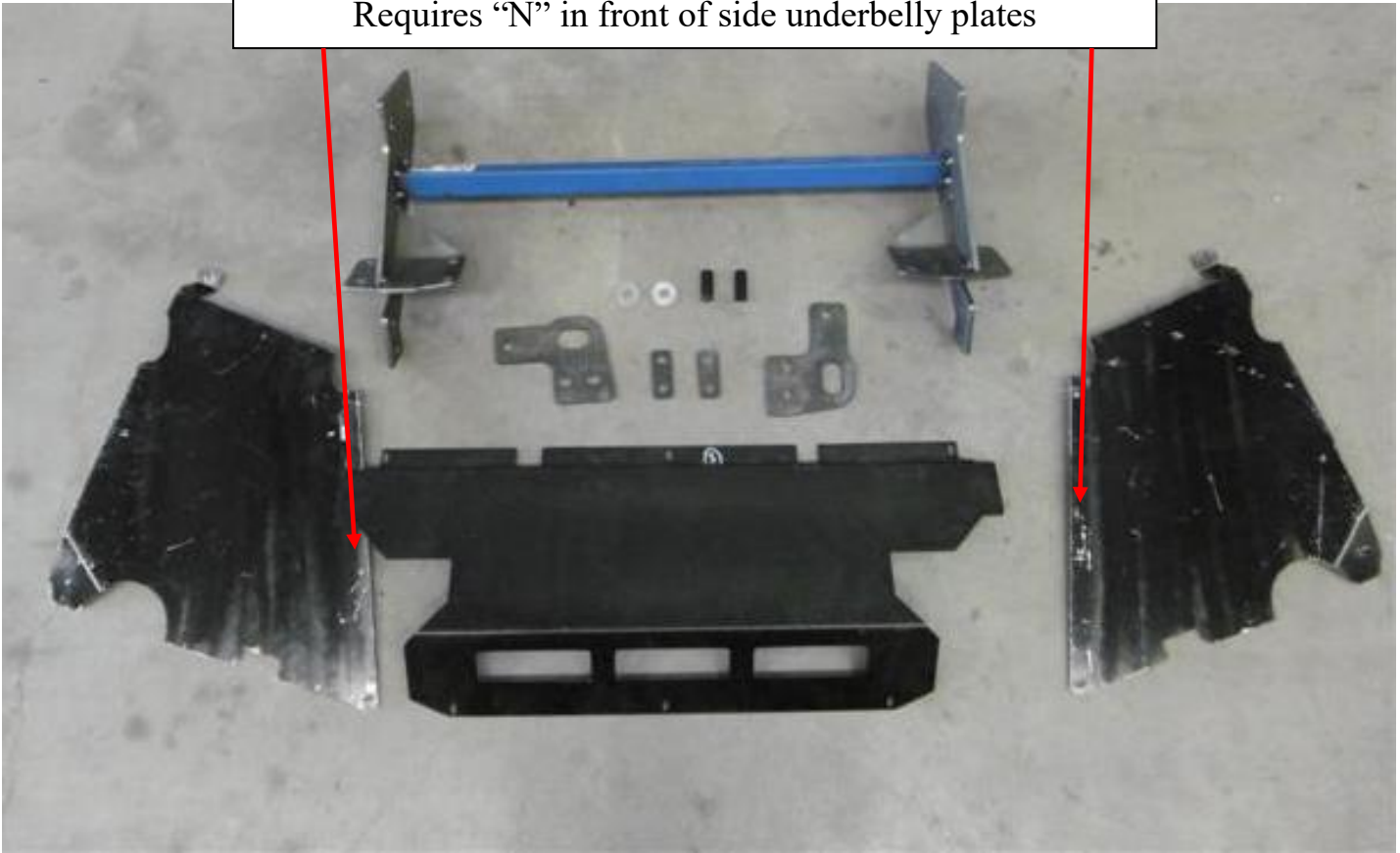

_____/_____
Wrapper's initials / Checker initials

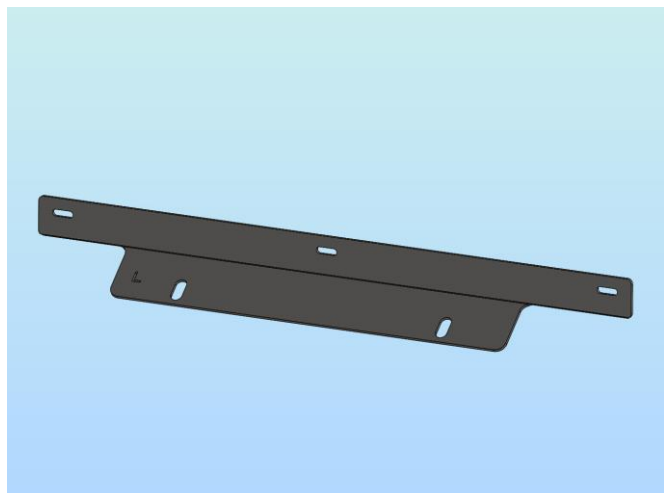
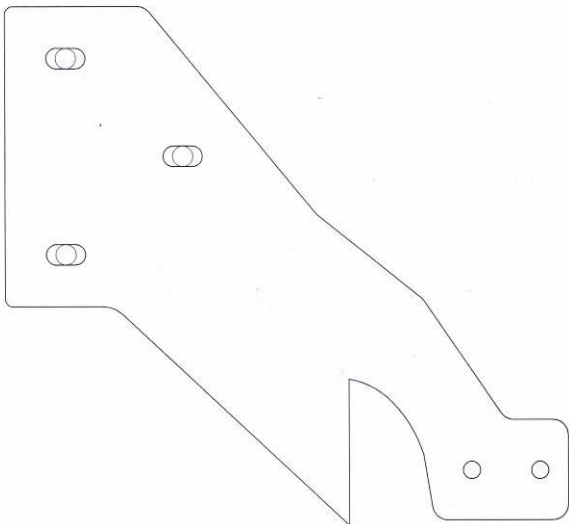

PROFILE MUST BE
STRAIGHT